

Introduction

This manual is intended to provide a description of the installation procedure for the SFA USB Connect pendant-mounted key reader.

Requirements

The USB Connect device will work with a CNC control with a standard DB25 RS-232 serial connection to the control box for the purposes of input/output of CNC data. Typically, the CNC manufacturer refers this as read and punch tape functions.

NOTE: Please see last page of this document for a Mounting Template

Please review the instruction manual thoroughly before beginning installation. In addition, the installer should verify that proper space and clearance has been taken into account prior to drilling holes in the CNC pendant. This includes cable bending radius and cable length.

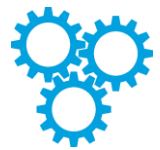

Mount the display to the control box.

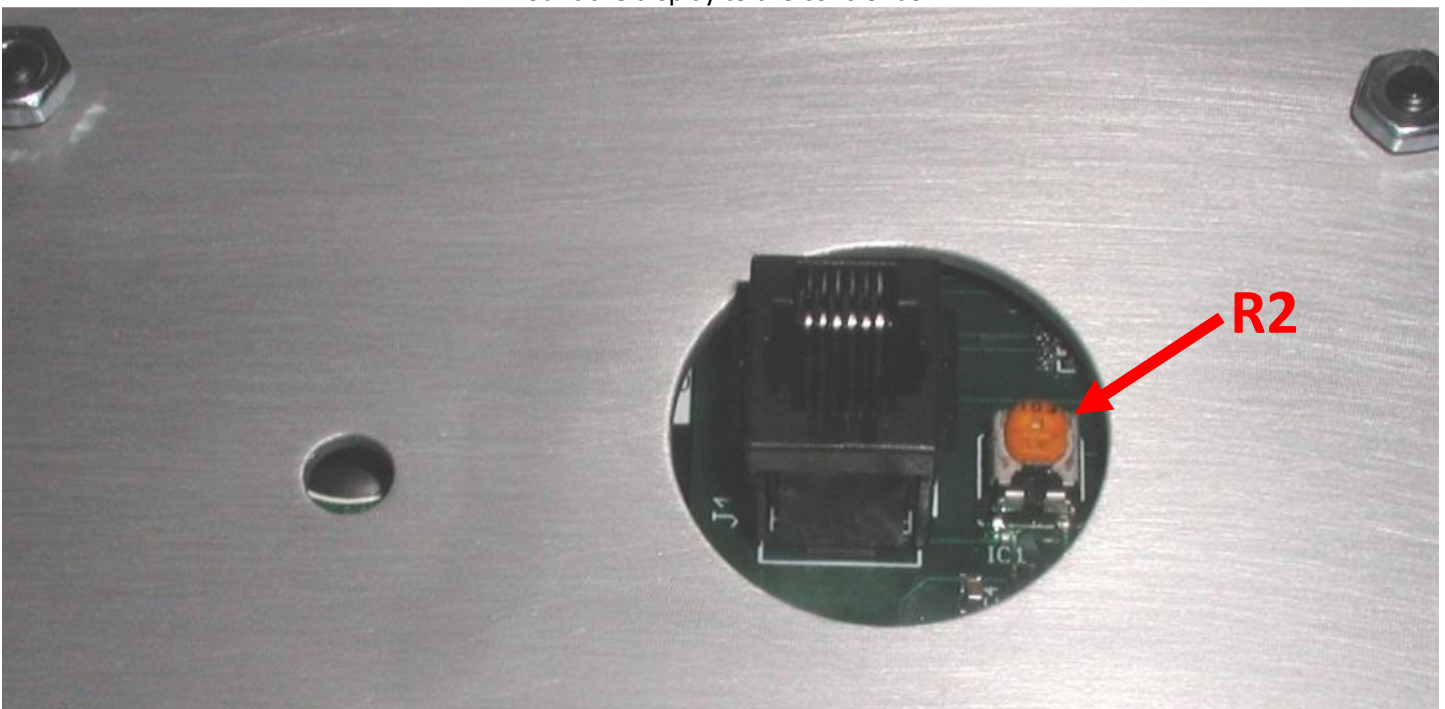

Inside the cabinet the RJ11 and the potentiometer should be visible through the large diameter hole. The potentiometer is used to adjust the brightness of the display as needed.

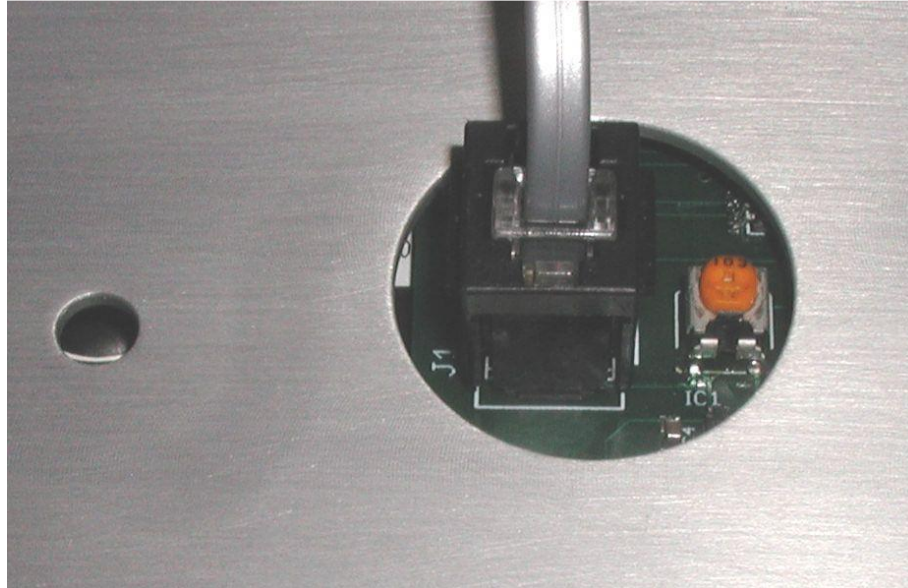

Plug the modular cable into the RJ11 jack. Note the length of the cable. The USB Connect controller board will need to be within cable length distance of the display when mounted. Locate a good position to mount the USB Connect controller board. It will need to be within the distance of the display cable, serial cable and the power plug. Secure the din rail as shown below.

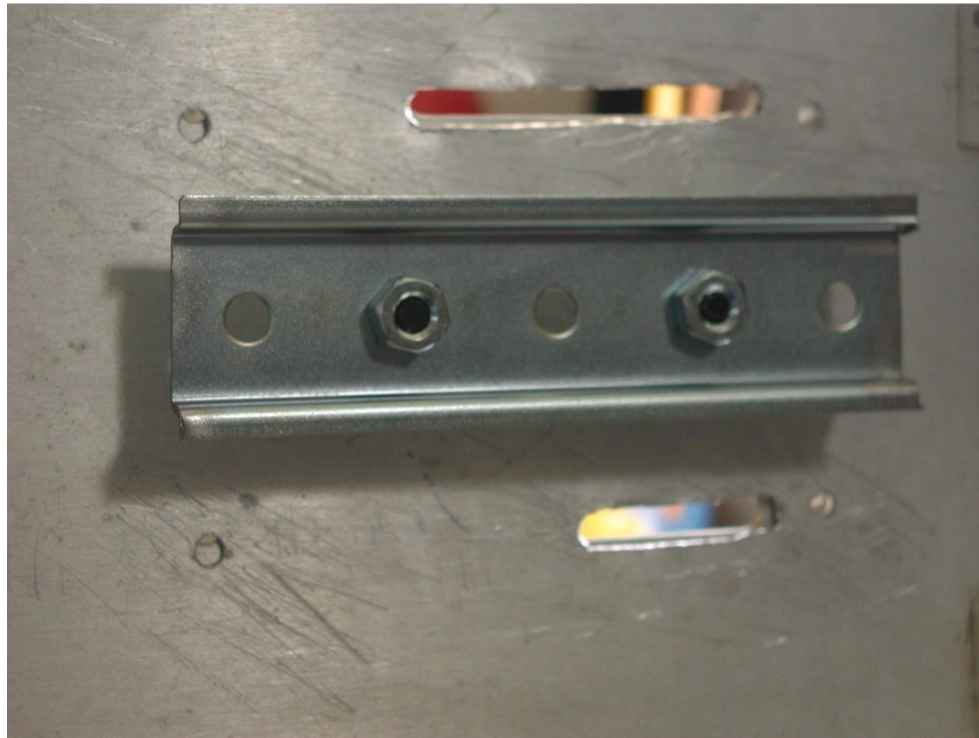

Attach the din rail clips to the USB Connect controller and mount to the din rail. Check for spacing. The two outer holes from the din rail clips can be used to release from the clips with a small screw driver.

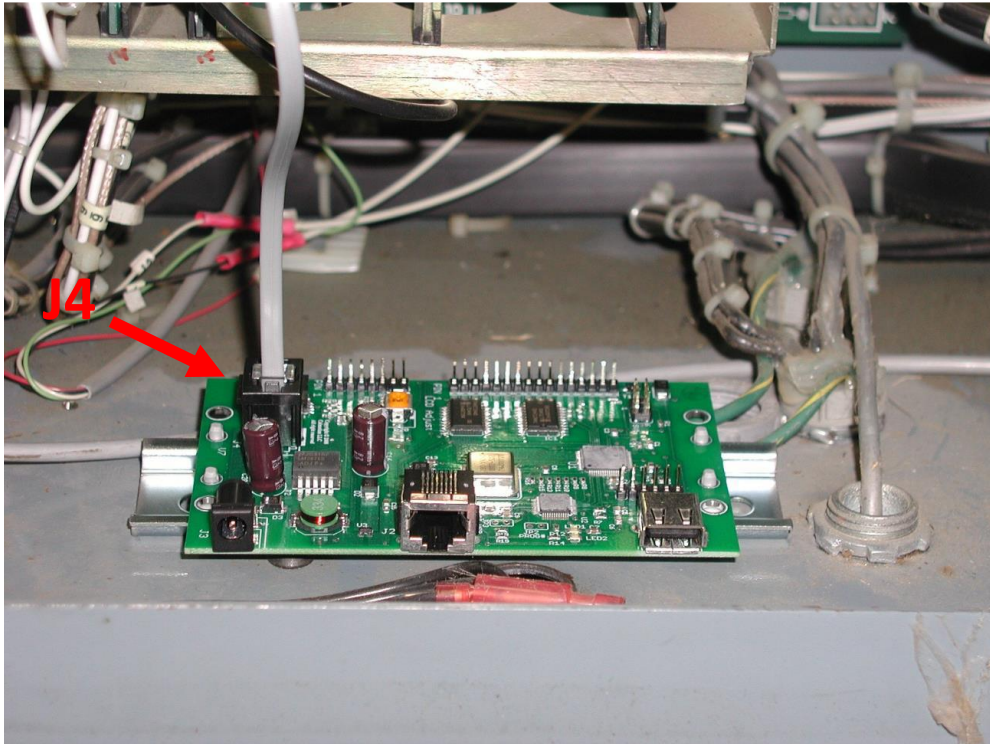
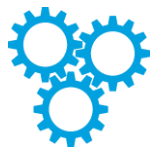

Plug the modular cable from the display into the RJ11 connector **J4** on the USB Connect controller board.

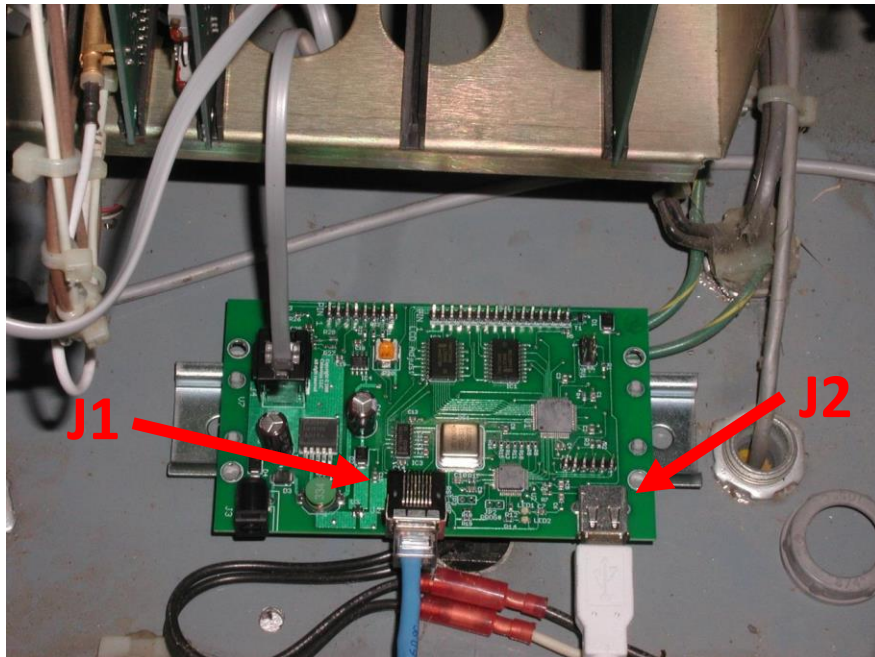

Plug the CAT5 cable into RJ45 labeled **J1** on the control board shown above. Later in the installation, the other end of the CAT5 cable will be plugged into the RJ45/DB25 plug.

Plug the USB cable into **J2** on the control board shown above. Later in the installation process, the other end of the USB cable will plug into the panel mounted USB connector.

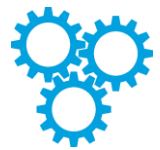

Choose a location for the panel mounted USB plug. Its location should be chosen for convenient connection of a USB key during normal operation of the machine. Punch a hole in the desired location to the dimensions shown below. Insert the panel mount USB connector through the hole and secure with the attached nut. Ensure that the gasket included with the kit is used to prevent contaminants from entering the enclosure. The cap of the panel mount USB connector snaps onto the connector house. (Note: the A side of the USB connector faces out of the pendant while the square B side of the USB connector faces into the pendant). Connect the USB plug to the controller with the USB cable provided.

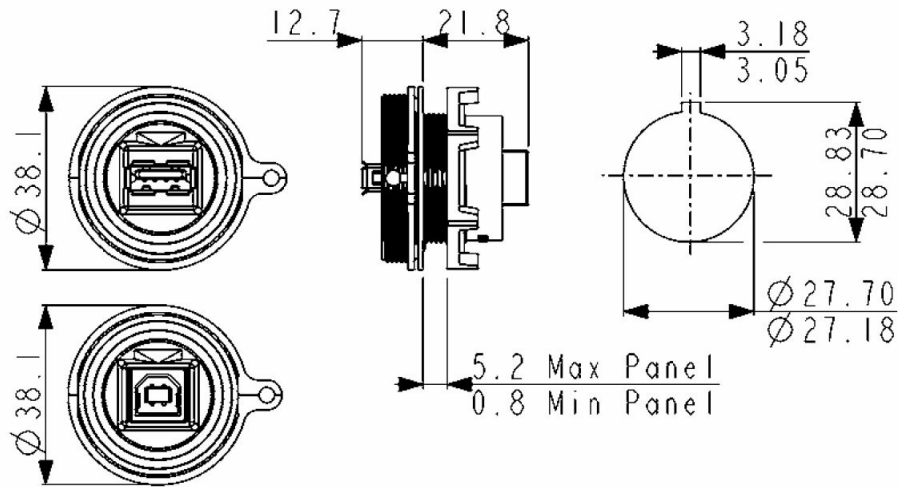

Locate the serial port connector of the CNC. Attach one end of the CAT5 cable to the serial port connector of the USB Connect controller. Attach the other end to one of the DB25 connectors included with the kit. Both male and female connectors have been provided. Choose one as appropriate. In most cases, it is best to simply pull the serial connector in from its mounting assembly and connect inside the pendant as shown below.

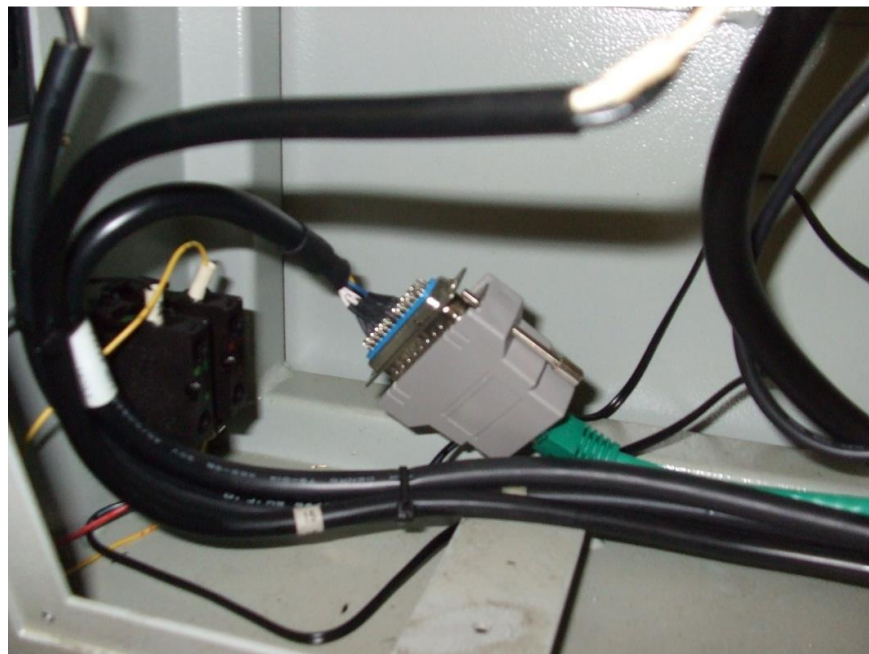



Connect the power plug provided to the printed circuit board. The power connection is center positive. The positive wire is identified with a white-stripe running the full length of the wire. The solid black wire should be connected to ground. The power supply can be anywhere in the range of 7-28 volts DC. Find a suitable power source in the cabinet and connect the flying lead connections to a power source. Apply power to the unit. A green LED should illuminate on the controller indicating that power has been applied. If properly connected, the keypad will also illuminate after a slight delay.

To Adjust the Display Contrast

An orange potentiometer (**R2**) located on the back of the display board can be used to adjust the contrast of the keypad display. This potentiometer should be accessible through the large diameter hole in the control box. (Note: the R20 on the USB Connect control board does **not** adjust the contrast).

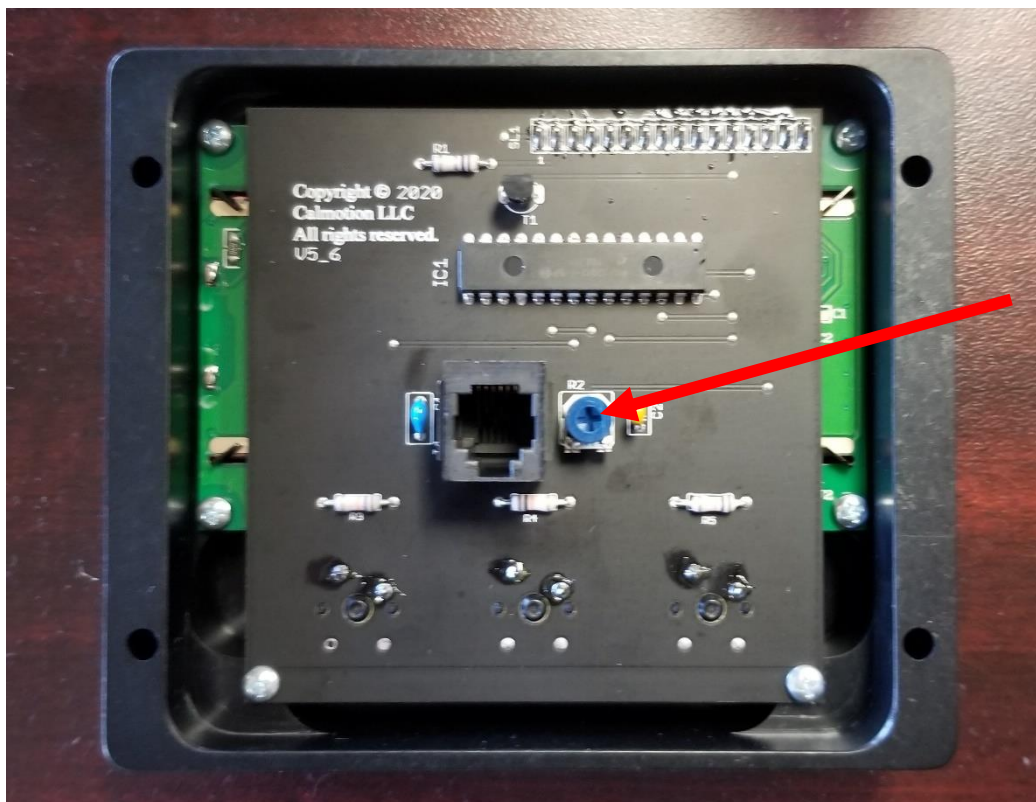

R2

USB/LAN Connect Pendant Mounting Template

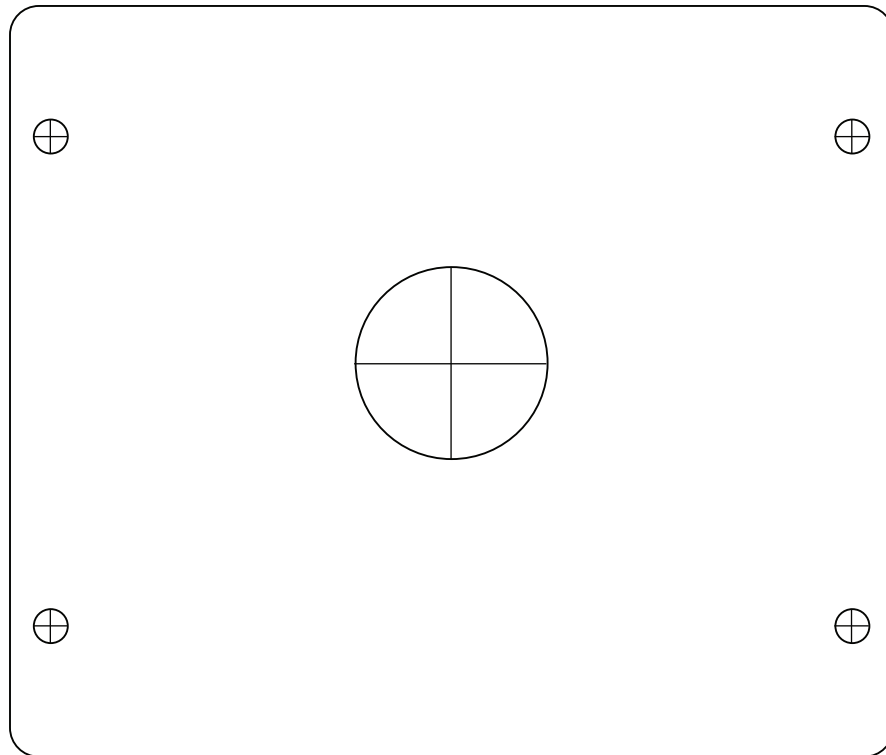

For More Documentation

manuals.shopfloorautomations.com

